

6 IMP. GAL. OPEN TOP CYLINDRICAL TANK

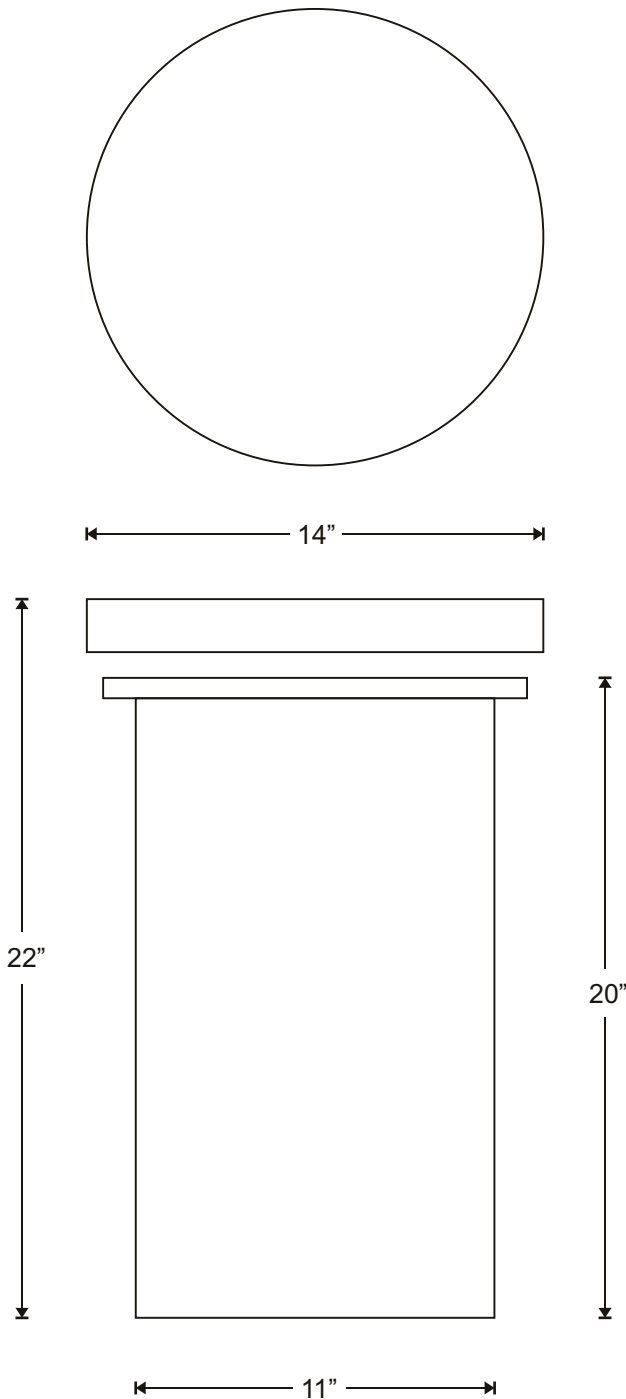

- HEAVY DUTY, ONE-PIECE, SEAMLESS POLYETHYLENE CONSTRUCTION
- EXCELLENT RESISTANCE TO IMPACT AND COLD WEATHER STRESS
- WON'T CRACK, RUST, OR CORRODE
- ULTRAVIOLET INHIBITORS PROVIDE PROTECTION AGAINST DETERIORATION FROM SUNLIGHT
- F.D.A. APPROVED FOR POTABLE WATER
- SUPERIOR CHEMICAL RESISTANCE AND COMPATIBILITY
- CLOSED TOP OR OPEN TOP AVAILABLE WITH COVER
- STEEL STANDS AVAILABLE TO YOUR HEIGHT REQUIREMENTS
- 2 YEAR WARRANTY
- DIMENSIONS: 11" DIA. x 20" H
- CAPACITY: 6 IMP. GAL. (27 LITRES)
- MODEL NO.: OTC006

*All Measurements are approximate

ZEEBEST PLASTICS

35 Calder Place, St. Albert, AB T8N 5A6
Ph: 780.447.5222 Fax: 780.455.9448
www.zeebest.com sales@zeebest.com