

ZST1650

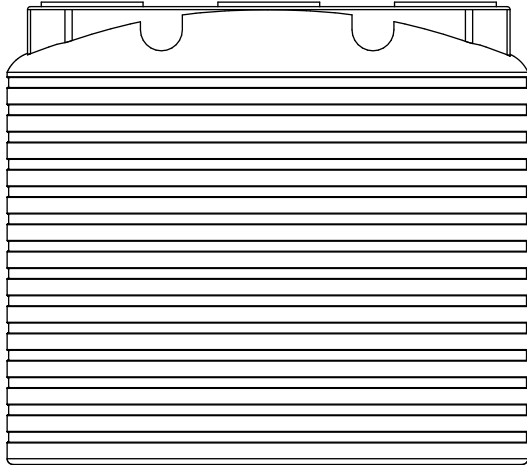

- **HEAVY DUTY, ONE-PIECE, SEAMLESS, POLYETHYLENE CONSTRUCTION**
- **FREE STANDING CONSTRUCTION, NO REINFORCEMENT REQUIRED**
- **EXCELLENT RESISTANCE TO IMPACT AND COLD WEATHER STRESS**
- **WON'T CRACK, RUST OR CORRODE**
- **ULTRAVIOLET INHIBITORS PROVIDE PROTECTION AGAINST DETERIORATION FROM SUNLIGHT**
- **SUPERIOR CHEMICAL RESISTANCE AND COMPATIBILITY**
- **DIMENSIONS: 87" Dia. X 83" High**
- **CAPACITY: 1650 IMP. GAL.
(7500 LITERS)**

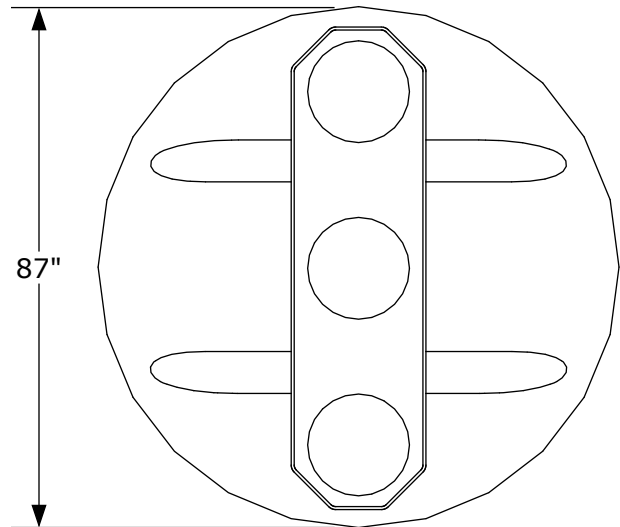
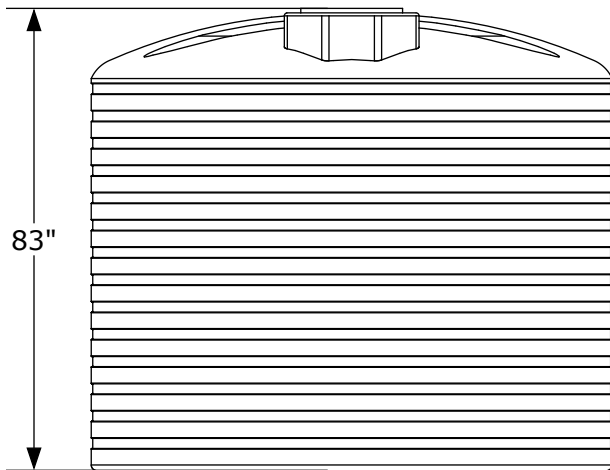

ZEEBEST PLASTICS

35 Calder Place, St. Albert, AB T8N 5A6
Tel : (780) 447-5222 Fax: (780) 455-9448
www.zeebest.com e-mail: sales@zeebest.com