

# TOP

GAS (TOP) / LIQUID (BOTTOM)  
PASS-THRU SLOT INSIDE TANK

HORIZONTAL STRUCTURAL REINFORCING RIBS  
(FULL CIRCUMFERENCE)

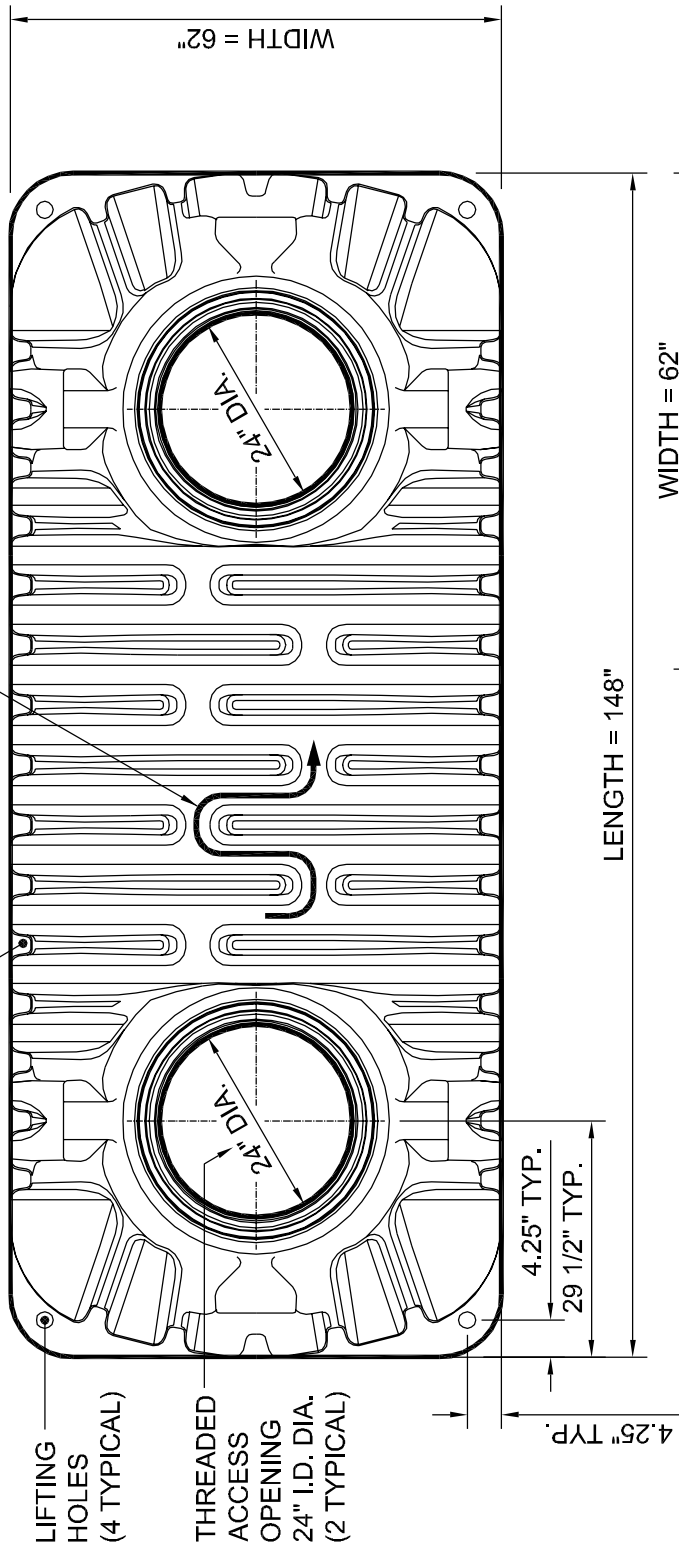

# SIDE

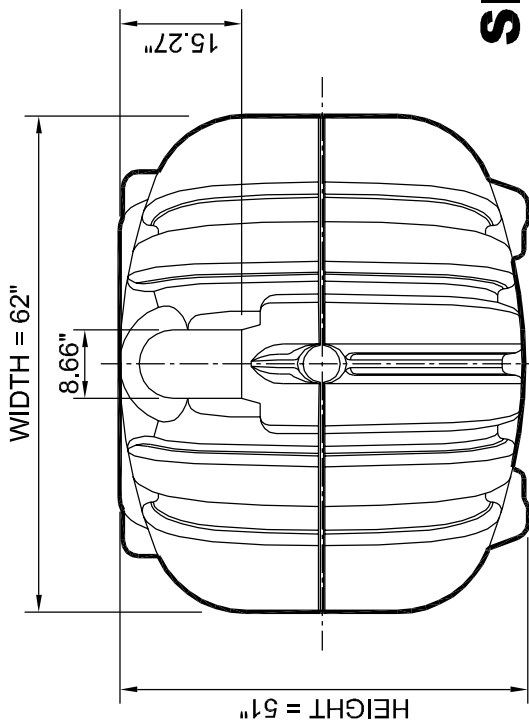

## TANK SPECIFICATIONS

DESIGN CAPACITY		TOTAL CAPACITY		WEIGHT	
GALLONS	LITERS	GALLONS	LITERS	POUNDS	POUNDS
1250	4730	1464	5541	560	560

DWG SCALE: 1:1

PLOT SCALE: 1:2

SHEET #: 1 OF 3

**ROTH MultiTank®**

**1250 GALLON / MODEL RMT-1250**

**Roth**  
YOUR ENVIRONMENT IS OUR BUSINESS.

ROTH GLOBAL PLASTICS  
One General Motors Drive  
Syracuse, N.Y. 13206  
Call Toll Free 866.943.7256  
www.roth.net

# ELEVATION

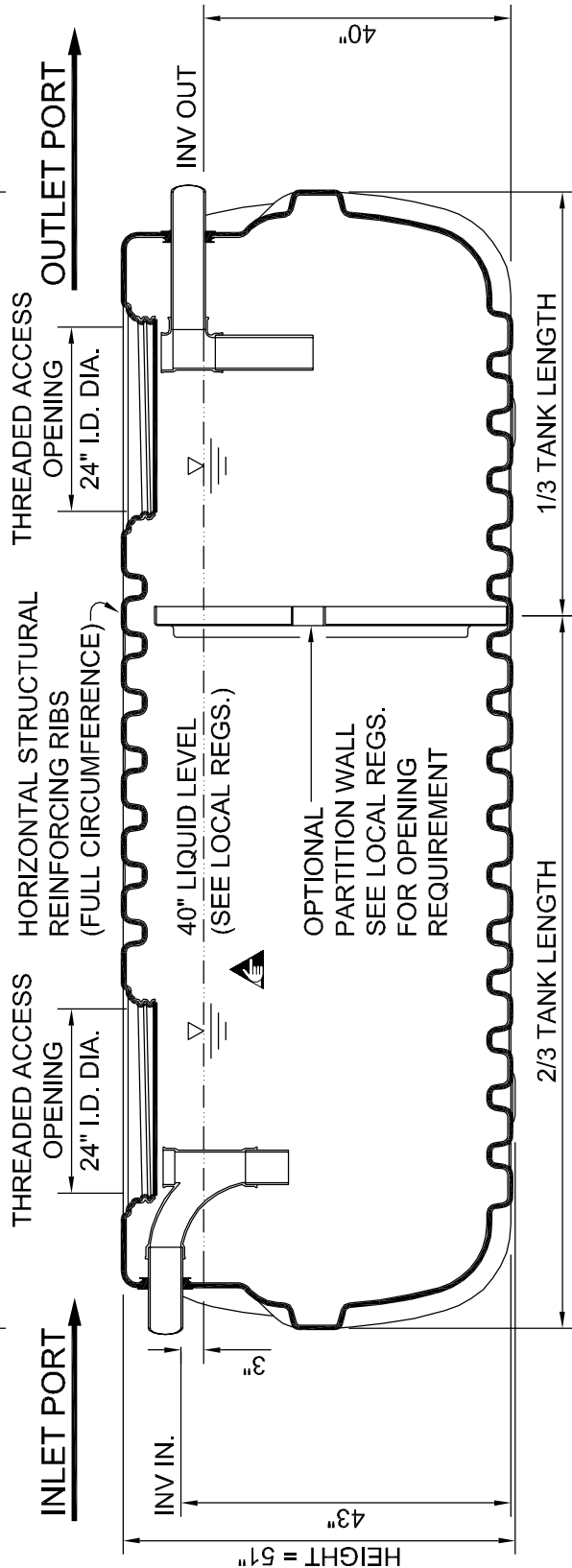
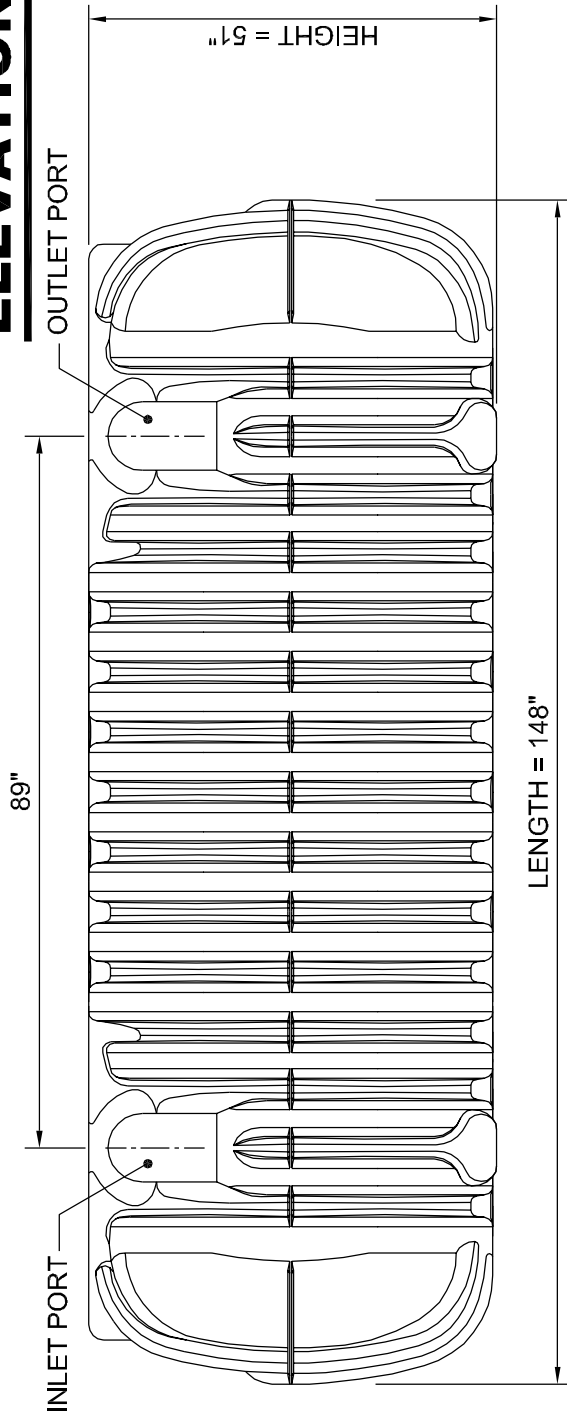

# SECTION

## 40" LIQUID LEVEL

DWG SCALE:	1:1
PLOT SCALE:	1:2
SHEET #:	2
OF	3

**ROTH MultiTank®**  
**1250 GALLON / MODEL RMT-1250**



ROTH GLOBAL PLASTICS  
 One General Motors Drive  
 Syracuse, N.Y. 13206  
 Call Toll Free 866.943.7256  
 www.rthlo.net

# ISOMETRIC

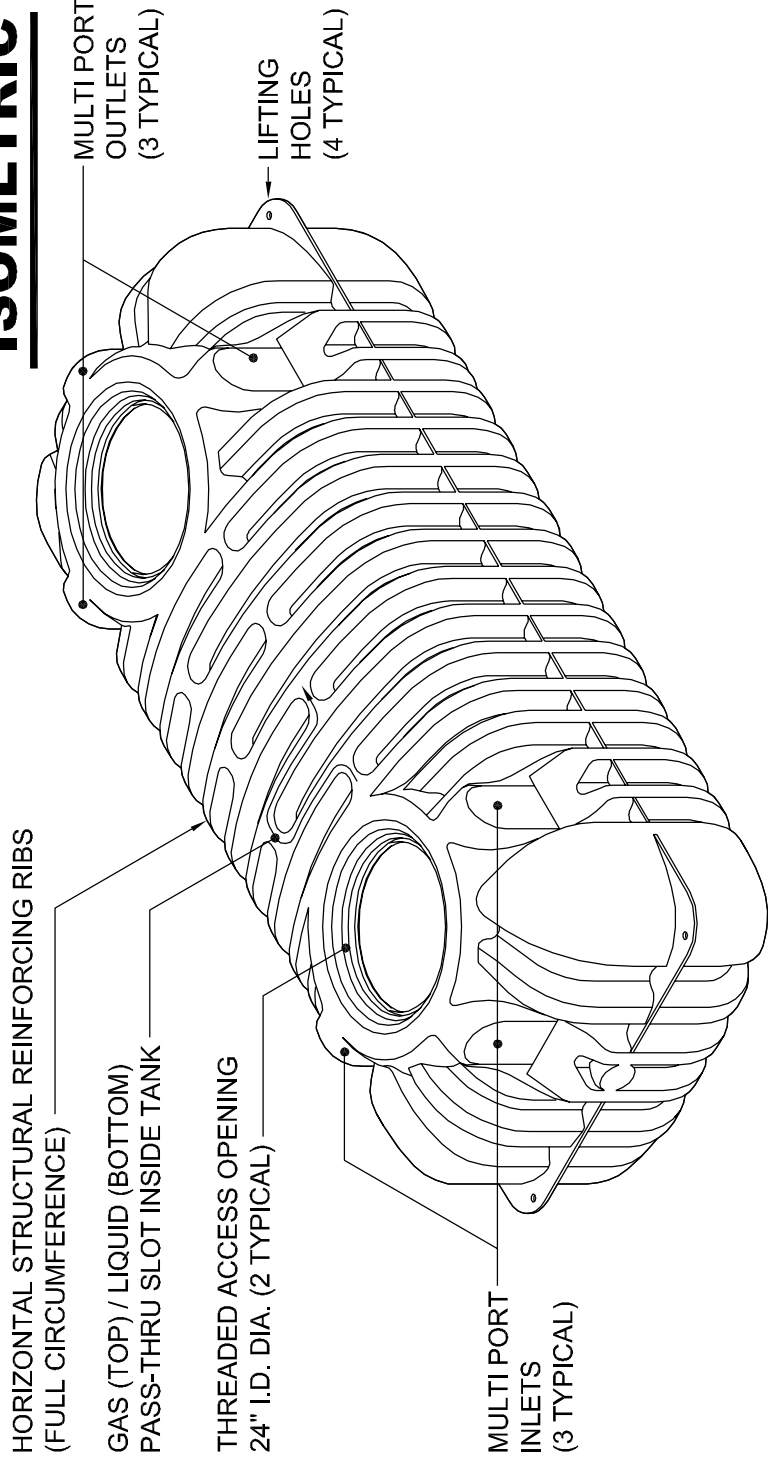

## TANK NOTES

1. Access at or above grade level must be secured against unauthorized access.
2. Tank is not rated for vehicular traffic loading.
3. All resin used is compliant with ASTM D 1248 as required by CSA B66 and IAPMO / ANSI Z1000-2007.
4. Tank material of construction is HMW-HDPE.
5. Primary dimensions are in inches
6. Minimum tank wall thickness is 1/4".
7. Labeling will include: manufacturer name, liquid capacity, date, maximum burial depth, and model number.
8. Riser cover contains the following: 6" x 3" warning:  
"Danger - Do not enter - Poison Gas" - written in English, French & Spanish.
9. Maximum burial depth from manufacturer is 36" unless specifically instructed otherwise by the factory.
10. Models RMT-750, RMT-1060, RMT-1250 and RMT-1500 are all certified to CSA and IAPMO standards.
11. Models RMT-500, RMT-900 and RMT-1000E are compliant with CSA and IAPMO standards.

## NOTES

DWG SCALE: 1:1

PLOT SCALE: 1:2

SHEET #: 3 OF 3

**ROTH MultiTank®**

**1 250 GALLON / MODEL RMT-1 250**



ROTH GLOBAL PLASTICS  
One General Motors Drive  
Syracuse, N.Y. 13206  
Call Toll Free 866.943.7256  
www.roth.net